

50-Way Network I/O

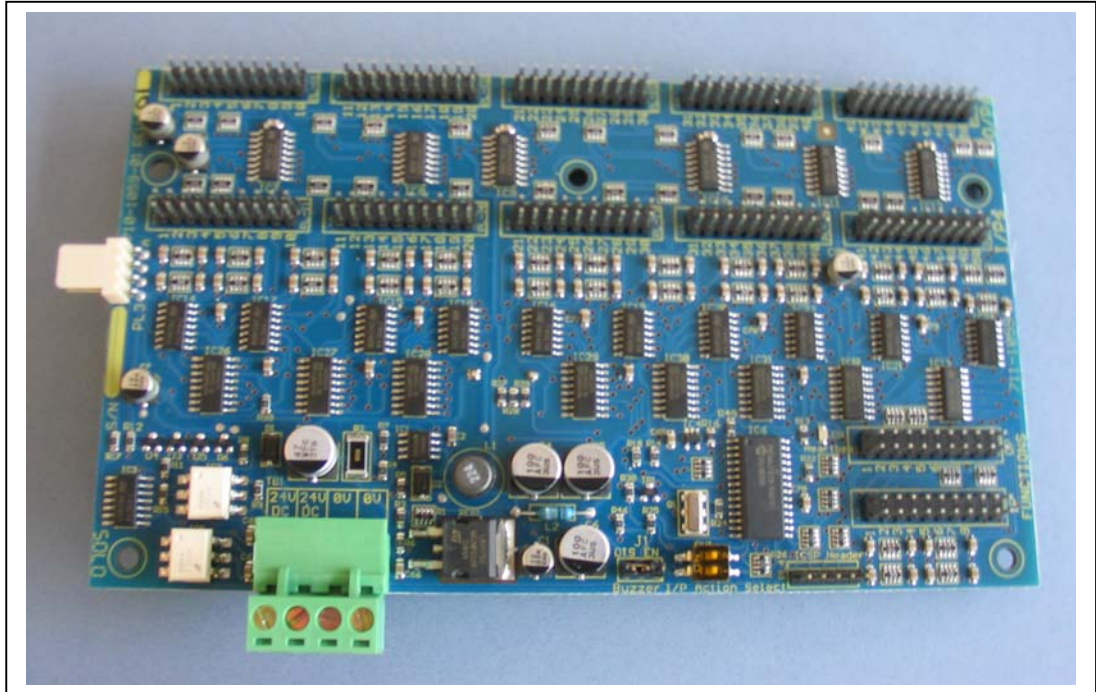

Features

- The *Mxp-045* provides a convenient and cost effective solution where multiple inputs and outputs are required.
- It is ideally suited for building control functions such as damper / fan control or sprinkler control where On/Off/Auto control and healthy/fault or open/closed status indication is required.
- The inputs can be configured as toggle (switch) or momentary (push-button) types.
- The outputs are fully programmable using the powerful '*DynamiX*' cause and effects rules for output groups 1-50.
- In addition to the 50 I/O circuits, dedicated inputs and outputs are also provided. Status outputs include General Fire, Fault, Disablement and Test. A buzzer is also provided for audible annunciation of status changes. Inputs include Buzzer Mute, Momentary input enable / reset and LED Test.
- The *Mxp-045* also provides all of the specified control and indication functions required for an evacuation panel in accordance with the NEN2535 standard for Netherlands.

Models, Sales Order Parts:

Mxp-045 (/FT):	50-Way Network I/O Controller (Unboxed).
Mxp-045-BX2 (/FT):	50-Way Network I/O Controller (type 2) c/w PSU and up to 56 LED indicators and up to 58 Switches fitted (Artwork required). (/FT): Denotes Fault tolerant version
Accessories:	Mxs-026 (Red), Mxs-026-YEL (Yellow) & Mxs-026-GRN (Green) LED Mxs-033 Non-illuminated push button Mxs-033-R (Red), Mxs-033-G (Green) Illuminated push button Mxs-031-2T 2-Position Key-Switch trapped Mxs-031-2U 2-Position Key-Switch un-trapped Mxs-031-3U 3-Position Key-Switch un-trapped

Applications / Limitations:

The 50-Way Network I/O controller is a stand-alone unit with / without its own EN54-4 power supply and charger. Each input and output on the card is fully programmable using a PC.
An additional 100 LED outputs can be provided using the 100-way driver card (Mxs-027) – Output Groups 101-200.

Compatibility:

The Mxp-045 is compatible with all Mx-4000 control panels from software revision 019-04 using the Ad-Net peer-to-peer network. The Mxp-045 is programmable using the Pc-NeT-03 Mx Configuration tool from revision 4.19 onwards.

Item	Specification Details
AC Supply (Boxed Versions)	220 – 240 V AC (+10 –15%) 50 – 60 Hz 1.6A. Support for up to 2 x 12V 7Ah batteries.
DC Supply (PCB) @ 24V DC	18-28V DC 63mA (/FT 101mA) + 0.8mA per LED energised + 1.3mA per switch energised
External Supply Monitoring	Monitored External Fault Input
Temperature & Humidity	-5°C to 50°C, 95% Humidity (non condensing)
Dimensions (Boxed Versions)	Type 2: Mimic Drawing: 358 W x 295 H, Enclosure: 450 H x 475 W x 115 D
Dimensions (PCB)	95 H x 245 W x 25 D
Output Drive Circuit (56)	3.3V 4mA current limited (for direct LED connection)
Input Circuit (58)	Volt-free, dry-contact inputs
Input / Output Contacts	Pitch 2.54 (0.1") gold plated
Buzzer	Frequency 4kHz, Sound Level 60dB (Fire) / 50dB (Fault) minimum @ 1m

As our policy is one of constant product improvement the right is therefore reserved to modify product specifications without prior notice

50-Way Network I/O

1 Table of Contents

1	TABLE OF CONTENTS.....	3
2	DESCRIPTION.....	4
2.1	Driver Card.....	4
2.1.1	Input / Output Type Configuration (SW1)	4
2.1.2	LED Driver Outputs.....	4
2.1.2.1	50-Way Outputs	4
2.1.2.2	Function Outputs.....	4
2.1.3	Switch Inputs.....	5
2.1.3.1	50-Way Inputs	5
2.1.3.2	Function Inputs.....	5
2.1.4	Buzzer.....	6
2.2	Interface Card and Interconnections.....	6
2.2.1	Power Input.....	7
2.2.2	Fault Input.....	7
2.2.3	Key-Switch Input.....	7
2.2.4	RS232 Interface.....	7
2.2.5	Network Connections.....	7
3	INSTALLATION	7
3.1	Mounting the Enclosure	7
3.2	Mounting the Card Assembly.....	8
3.3	Wiring.....	8
3.3.1	DC Power Supply.....	8
3.3.2	Fault Input.....	8
3.3.3	Network Connections.....	9
3.3.4	Connecting LED Indicators to the driver card.....	9
3.3.5	Connecting Switches to the driver card.....	9
3.3.6	LED / Switch Mating Connectors.....	10
4	NETWORK CONFIGURATION AND IDENTIFICATION.....	10
4.1	Default Settings.....	10
4.2	Changing the Interface Settings.....	10
4.3	Updating the Unit from the PC Tool (Upload).....	10
5	PROGRAMMING	11
5.1	Interface selection.....	11
5.2	Output Group Configuration.....	12
5.2.1	Evacuation Panel.....	13
5.2.2	General I/O Panel.....	13
5.3	Switch Input Configuration	14
6	EXAMPLE – EVACUATION CONTROL AND MIMIC PANEL	16
6.1	Input Configuration.....	16
6.2	Output Configuration.....	16
7	MAINTENANCE.....	18
7.1	Lithium Battery	18

2 Description

The 50-Way Network I/O Controller comprises of the Mimic Interface Card (PCA1040) and the 50-Way I/O Driver Card (PCA1059). The driver card is mounted on top of the interface card using spacers (pillars).

The driver card, shown opposite, provides the following input and output circuits.

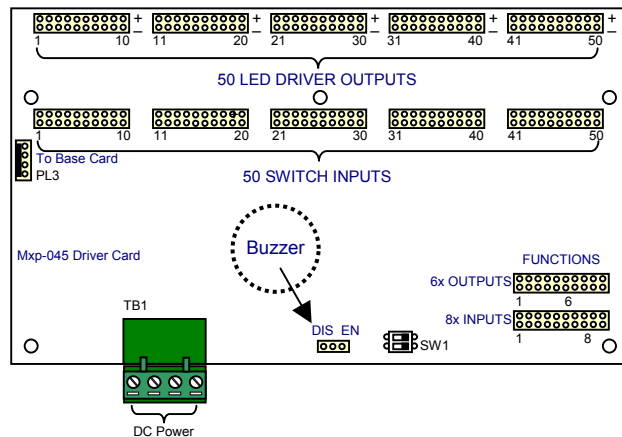

Figure 1 - Card Layout

2.1 Driver Card

2.1.1 Input / Output Type Configuration (SW1)

The operating characteristics of the 50-Way Inputs and outputs can be configured as follows:

SW1:2	SW:1	EVAC Inputs (Momentary)	General Inputs (Toggle)	EVAC Outputs (with Silence)	General Outputs (without Silence)
OFF	OFF	01 – 50	--	01 – 50	--
OFF	ON	--	01 – 50	--	01 – 50
ON	OFF	01 – 16	17 – 50	01 – 16	17 – 50
ON	ON	01 – 08	09 – 50	01 – 08	09 - 50

Table 1 - SW1 Settings

NOTE: For a 50-Way Evacuation Panel or a 50-Way General Input Panel, then all inputs can be assigned to the same zone. For a combined function Evacuation / General Input Panel, then the evacuation inputs must be assigned to one zone and the general inputs must be assigned to a different zone. All inputs can, in any event, be assigned to individual zones if required.

2.1.2 LED Driver Outputs

There are 56 LED Driver Outputs in total comprising 50 programmable and 6 dedicated function outputs. The LED Driver Outputs are specifically designed for direct connection to an LED. No additional series resistance is required. The outputs are current limited to 4mA drive.

2.1.2.1 50-Way Outputs

The operation of the 50-Way outputs is in direct response to their equivalent output group number (1-50). For example, if Output Group 1 cause and effect condition has been qualified and is active then output number 1 LED will turn on. Program the required cause and effect on the PC Configuration Tool for each Output Group required.

When the unit is configured with evacuation modes, the respective evacuation area LED outputs will be turned off when the bells / sounders are silenced. In this way, the LED output will follow the operation of the bells / sounders in the specified area. The LED will be ON when the bells are ringing and will be OFF when the bells are silenced.

General Outputs remain ON so long as the Output Group is qualified and active.

2.1.2.2 Function Outputs

There are six (6) dedicated function outputs. These turn on as follows:

Output	Function	Description
1	Fire	ON = General Fire
2	Fault	ON = General Fault
3	Test	ON = Zone in Test
4	Disablement	ON = General Disablement
5	Power	ON = DC Power is OK
6	MOM EN	ON = Momentary Input Operation is Enabled

Table 2 –Function Outputs

2.1.3 Switch Inputs

There are 58 Switch Inputs in total comprising 50 programmable and 8 dedicated function inputs. The inputs are compatible with volt-free (dry-contact) type inputs. DO NOT connect to a voltage source.

2.1.3.1 50-Way Inputs

The 50-Way Inputs can be configured (using DIP Switch SW1) to operate as toggle (switch) or momentary (Evacuation push button) action.

Momentary (Evacuation) inputs are enabled via Function Input No 8. On activating a momentary input, the input is latched by the card. Activating the Function Input No 7 clears all activated (latched) inputs and issues a network 'Silence' command to turn off all bells / sounders.

The function of each input can be assigned to any of the available actions available in the fire alarm control panel such as fire, fault, alarm, control input, etc. Program the required action on the PC Configuration Tool. The default is Alarm-1 action for all inputs.

2.1.3.2 Function Inputs

There are eight (8) dedicated function inputs. All inputs must be connected to push-button type momentary action switches. These operate as follows:

Input	Function	Description
1	Reset	General Reset Input Action (will reset the fire alarm system)
2	Buzzer Mute	Mutes the internal buzzer
3	Silence	Turns off the bells / sounders
4	Resound	Turns on the bells / sounders
5	LED Test	Causes all LED outputs to turn on and the buzzer to sound
6	--	Not defined
7	PB RST	Clears (resets) all activated (internally latched) momentary push-button inputs and generates a network silence command.
8	PB EN	Enables the operation of the momentary push-button action inputs for five (5) minutes from the last button press (short / jumper across the input to permanently enable the momentary inputs).

Table 3 – Function Inputs

Inputs 1-6 are pre-defined to the actions listed above in the default PC Configuration. Only Input 6 can be changed and defined, using the PC Configuration Tool, if required.

2.1.4 Buzzer

The driver card is equipped with a buzzer that activates on a change in state (i.e. fire or fault) in the same way as in the fire alarm control panel.

It is possible to mute the buzzer using one of the function inputs.

Moving the jumper from the EN position to the DIS position on the three-way header will permanently disconnect the buzzer. In this mode, the buzzer will not sound for alarm, fault or alarm conditions. However, it will continue to provide an audible feedback to confirm button presses.

The buzzer will activate during a LED test.

2.2 Interface Card and Interconnections

The interface card, its internal connections to the driver card and its external connections are shown in Figure 2 below.

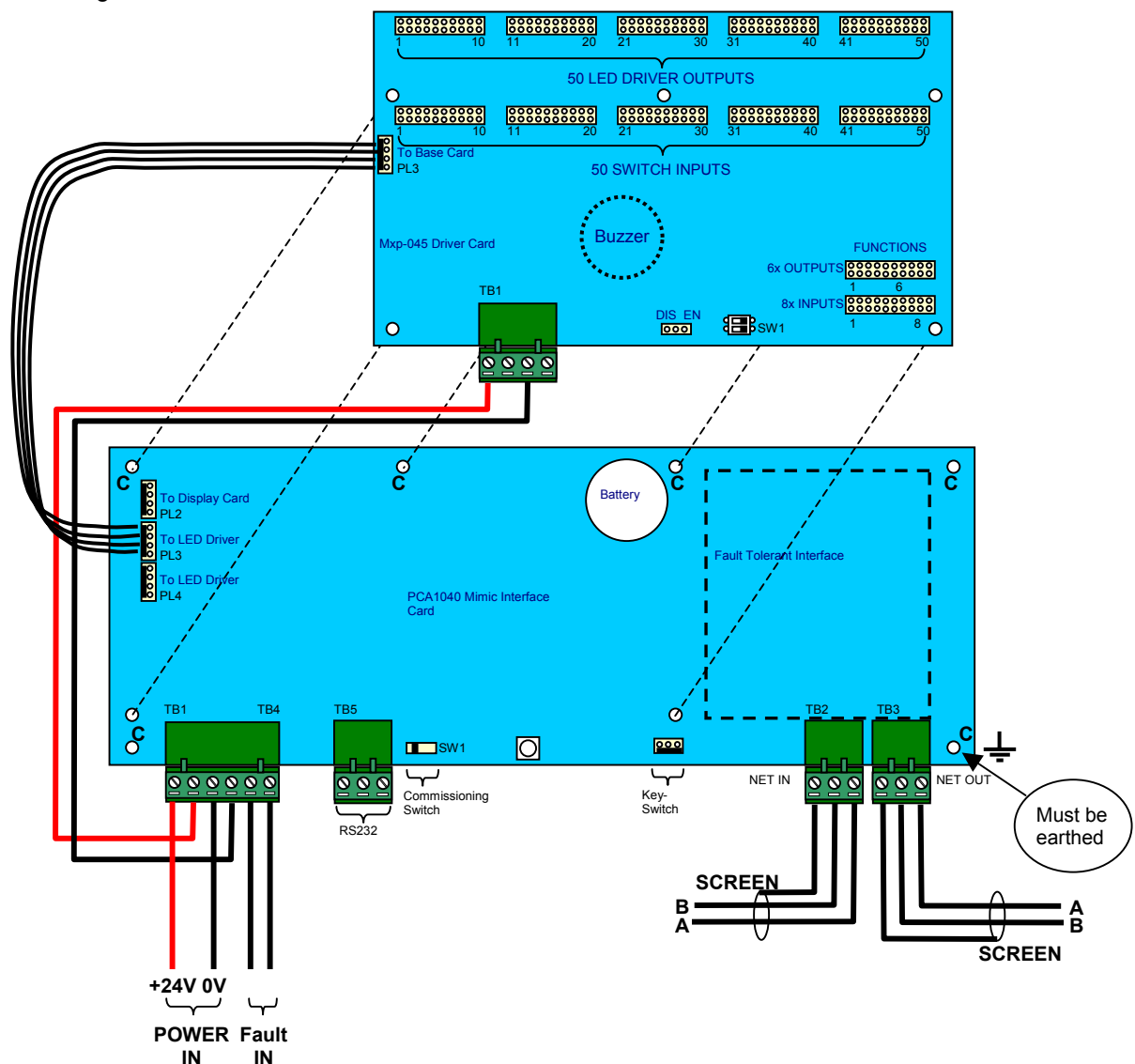

Figure 2 - Card Interconnections

The interface card and driver card are supplied as an assembly fitted with the inter-board 24VDC power leads and ribbon cable. Power and normal operation of the interface card is indicated by the 'heartbeat' LED flashing at a rate of 1Hz.

2.2.1 Power Input

A 24V DC Power input is required.

2.2.2 Fault Input

An EN54 power supply with clean-contact fault output contacts can be monitored for fault conditions.

2.2.3 Key-Switch Input

This input can be used as an alternative LED Test input for a 50-Way General I/O panel only. This will activate the LED outputs only and will not activate the buzzer.

For Evacuation Only and Mixed Evacuation / General I/O Panels then Function Input No. 5 MUST be used for the LED Test Function.

2.2.4 RS232 Interface

This input is for connection to a PC for configuration use.

2.2.5 Network Connections

These input and output connections are for connection to the AdNeT network. Any faults detected by the interface card (e.g. power supply fault) are reported back over the Ad-Net network.

For full information on the installation of the network, and for a list of recommended cables, refer to the AdNeT Network Guide – Document number 680-027.

3 Installation

3.1 Mounting the Enclosure

The fixing points and dimensions of the boxed version are shown in the diagram opposite.

For details of the 230V AC Power wiring, refer to the power supply manual supplied with the unit.

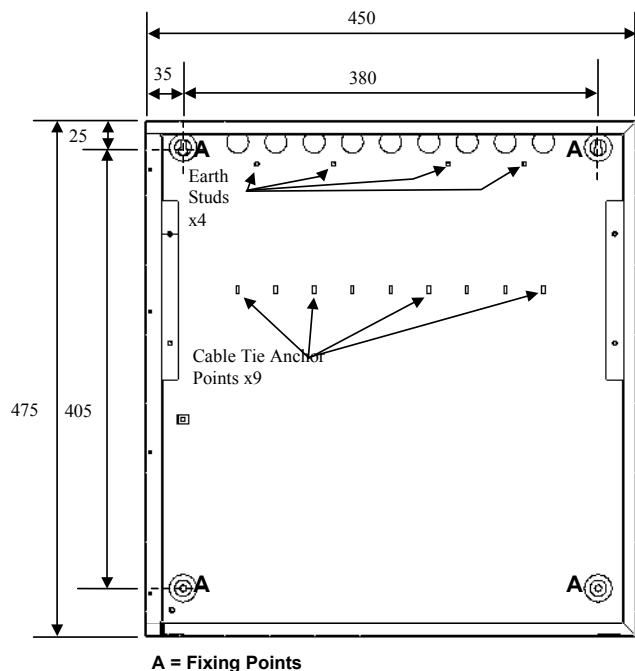

Figure 3 – Enclosure BX2

3.2 Mounting the Card Assembly

The card is provided with six (6) M3 fixing holes (marked C in Figure 2). Mount the card in a suitable enclosure using M3 spacers (minimum 10mm length). Note that the bottom right hand fixing point **MUST** be connected to the enclosure to provide a ground reference for the network connections.

3.3 Wiring

The unit is designed for easy wiring installation.

“Plug-in” terminal blocks are provided for all connections to the unit.

Figure 2 above shows the positions for all connections to the unit.

NB: Minimum / Maximum cable size for terminal block connections is limited to 0.35mm² - 2.5mm² (22-14AWG).

All electrical wiring installation work should be carried out in accordance with the code of practice applicable in the country of installation.

To maintain electrical integrity of the SELV wiring on the DC Power and Communications lines all SELV wiring should be segregated from LV mains wiring and be wired using cable with insulation suitable for the application.

To minimise the effects of EMC interference all data wiring circuits should be wired with a twisted pair of conductors with a cross sectional area suitable for the loading conditions.

In areas where cabling may come into contact with high frequency interference, such as portable radio transceivers etc. the data wiring cable should be of a twisted pair construction within a overall screen. Care should be taken to correctly terminate this screen, refer to the information below.

3.3.1 DC Power Supply

A 24V DC power supply is required for both the interface and the driver cards.

Connect the 24V DC supply feed input to the SUPPLY +24V and 0V terminals on the interface card.

Connect the 24V DC from the interface to the driver card.

Use cables of sufficient size to ensure that the power input voltage is maintained under all supply conditions – refer to specifications section.

OBSERVE POLARITY OF CONNECTIONS

For boxed versions, supplied complete with a power supply, refer to the additional power supply technical data sheet supplied for details of the AC connections.



Connect the incoming power supply earth wire to the earth stud in the back box.

Note: The DC power supply used **MUST BE** designated a Safety Extra Low Voltage (SELV) supply.

3.3.2 Fault Input

The “FAULT INPUT” terminals are normally used to monitor the “normally closed” contacts of the fault relay output from the power supply.

A 10K Ω series resistor should be connected to the relay terminals.

If more than one module is powered from the same power supply, it is only necessary to connect the fault output monitoring to one of the modules.

Should no fault relay be available, or if the monitoring of an external fault signal is not required, these two terminals should be shorted together with a 10K Ω resistor across the terminals of the “FLT-INP” terminal block.

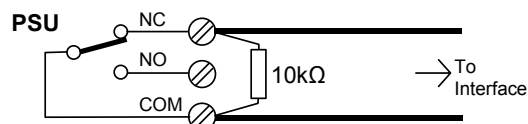

Figure 4 – Fault Relay Input / EOL Circuit

3.3.3 Network Connections

Connect the 2 core twisted pair network data cable to the A and B terminals.

Connect the data cable screen to the network SCN terminals. Note that special screen termination circuits are included on the circuit card to prevent mains frequency earth-loop currents flowing between network nodes.

The data cable screen **MUST NOT** be connected to any other earth point.

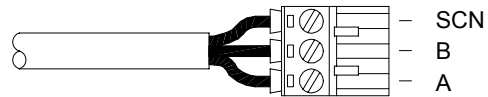

Figure 5 – RS232 Connections

Please refer to document 680-027 for more detailed information on the Ad-Net network.

3.3.4 Connecting LED Indicators to the driver card

Each output is capable of sinking approximately 4mA.

It is recommended that 'High Efficiency' LED's are used. High visibility, high viewing angle LED's, with colour-coded leads, are available with sockets ready-made to connect to the driver card (Part code MXS-026).

Plug the LED two-pin socket into the required output point on the pin headers.

Correct polarity must be observed as shown below. Note the "+" and "-" markings on the PCB and that the red lead, of the MXS-026 LED assembly, is connected to the "+" terminal.

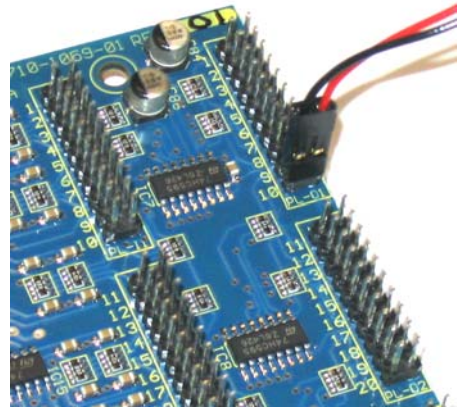

Figure 6 – LED Plug Connections

Loom and tie in the LED leads so that no strain is applied at the LED or the connector as the hinged display plate is opened or closed.

3.3.5 Connecting Switches to the driver card

Each Input must be connected to a volt-free (dry-contact) switch having a minimum contact rating of 30V AC/DC 0.1A and having a maximum contact resistance of 100mΩ (i.e. suitable for low current 1mA switching).

Two and three position key-switches (trapped or un-trapped) and push-button switch assemblies (with / without integral LED indicator) with sockets ready-made to connect to the driver card are available. The connections for switches are not polarity sensitive.

Plug the Switch two-pin socket into the required input point on the pin headers (this is a similar arrangement to the LED connection described above). Loom and tie in the Switch leads so that no strain is applied at the Switch or the connector as the hinged display plate is opened or closed.

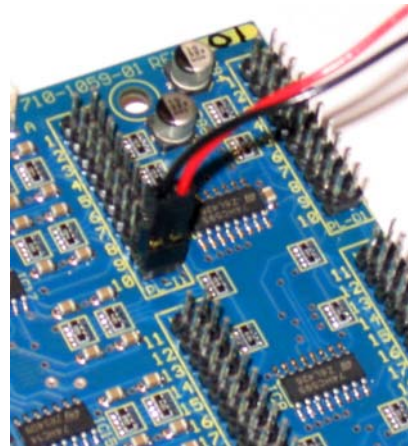

Figure 7 – Switch Plug Connections

(Mimics / fascia layouts tend to be unique, but it is often easier to fit the LED Indicators and Switches and plug them all into the appropriate sockets prior to forming the loom).

3.3.6 LED / Switch Mating Connectors

The connectors on the board are compatible with ribbon cable IDC connectors and individual 2-Way crimp connectors as follows:

	2-Way Housing	Crimp (22-26AWG)
Harwin	M20-1060020	M20-1180022
Bergcon (FCI)	65039-035	47745-001
AMP (Tyco)	87499-3	87667-5

4 Network Configuration and Identification

4.1 Default Settings

The following factory default settings are used, but these can be changed as required.

```

Network Node : 50
Next Node : 1
Interface Zone : 200
    
```

Note that if multiple mimics, or other network interfaces, with the same default settings, are installed, it is essential that the defaults are changed to give unique parameters for each interface.

4.2 Changing the Interface Settings

Set Switch SW1 to Commissioning Mode, then use any of the following: -

- Connect a PC to the interface cards RS232 connector and using the MX CONFIG software, transfer a file from the PC to the Interface. **This is the preferred option.**
- Connect a PC to the interface cards RS232 connector and run the “Virtual Terminal” display and select “Commission – Setup” from the virtual display.
- Connect a standard panel display via a 4-way ribbon cable to PL2 on the interface card and select “Setup” from the display.

“Zone Text” should also be entered so that any fault information from this mimic (e.g. power supply fault) can be readily identified from other displays on the network.

Set Switch SW1 back to Normal Mode (Remember, when using the display or virtual terminal, to Escape to the main commissioning menu first).

4.3 Updating the Unit from the PC Tool (Upload)

Connect the PC Lead to the RS232 connector on the interface card.

Move the switch (SW1) to the Commissioning position. Refer to the picture opposite.

Transfer the file (upload) from the PC to the Interface.

Move the switch (SW1) to the Normal position. Refer to the picture opposite.

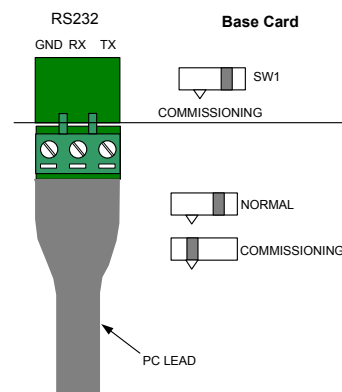

Figure 8 – RS232 and Commissioning Mode Select Switch

5 Programming

It is necessary to program the operation of the interface using the PC Configuration Tool. It is not possible to program the operation of the inputs and outputs on the unit itself.

5.1 Interface selection

The basic product to be selected is a Network Mimic Interface. This is compatible with both mimic driver cards and the 50-way I/O card.

Add a new device and select the mimic panel option. Assign the node and name for the interface.

The interface is added into the tree structure.

The functionality for the 50-Way I/O Interface must be added to the basic mimic interface. Expand the interface tree structure and click on the I/O Interface option.

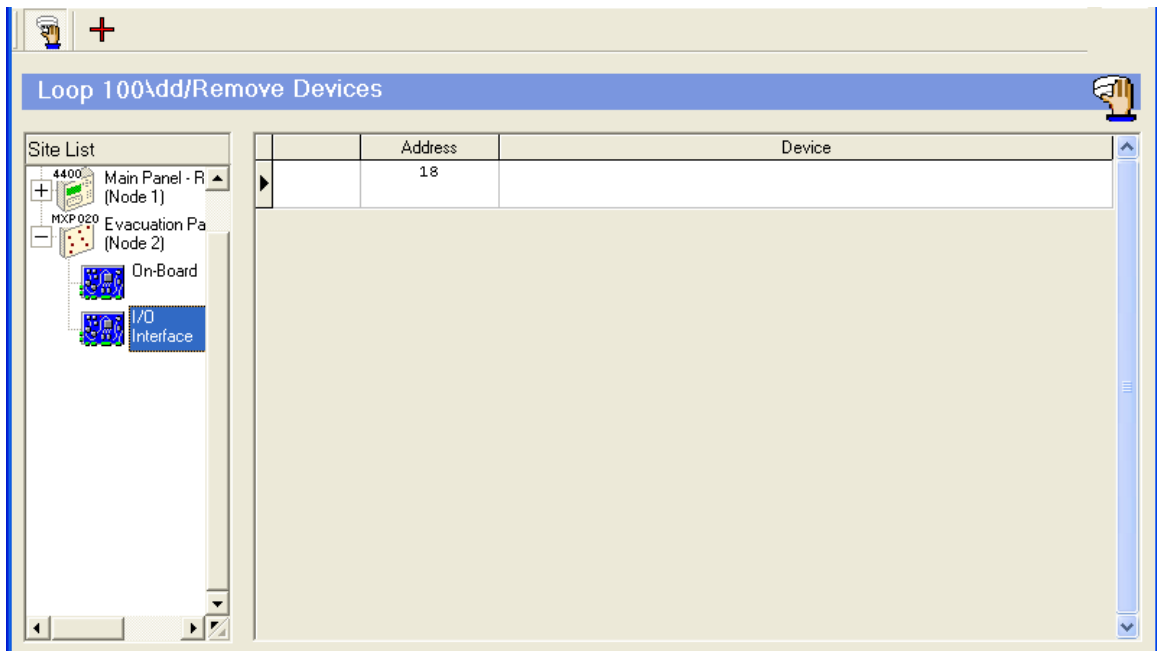
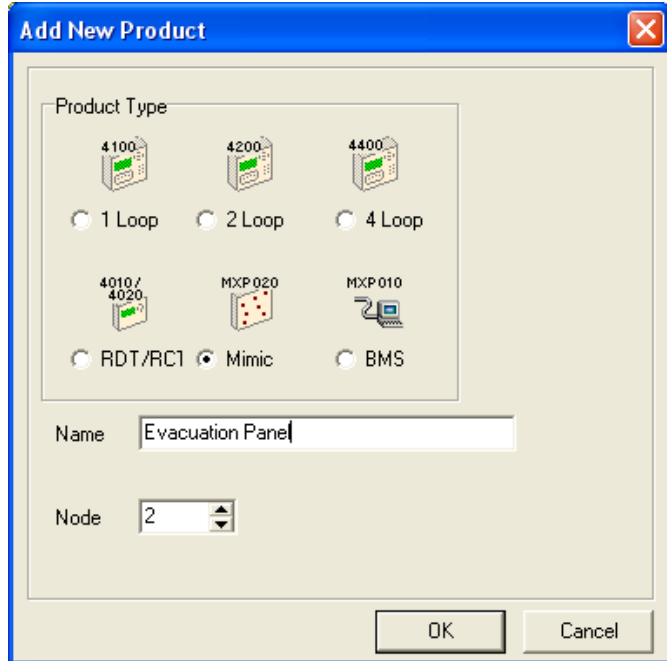

Add a device by clicking on the '+' option button and a list of devices will be shown. Expand the tree structure as required. See below:

Three options are presented. The options are basically the same but the default programming is preconfigured per option to the most common input and output functions. These are an aid to configuration only – remember that the basic operation (momentary / switch) for the 50 inputs is defined using the DIL switch on the card itself and the actions for each input / output can be easily configured as described below.

The three options are described in the table below:

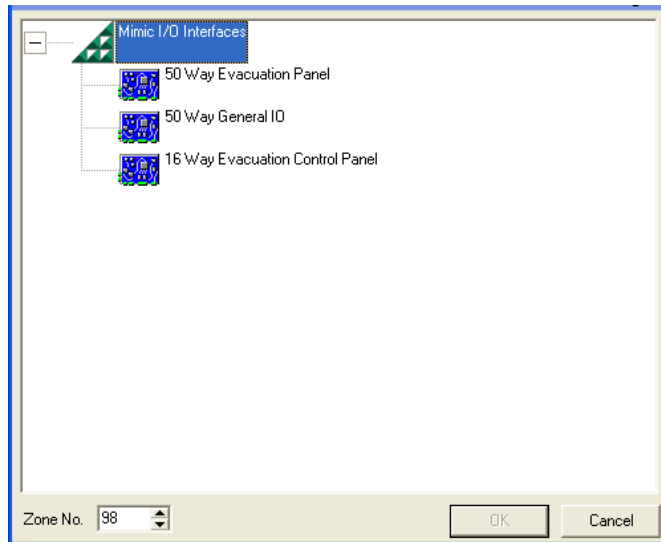

Option	Description
50-Way Evacuation panel (Mxp-045)	50 inputs are configured to the Alarm 1 action. 6 function inputs are configured to defined actions. 50 Basic Output groups are configured.
50-Way General I/O (Mxp-045)	50 inputs are unassigned (No action) 6 function inputs are configured to defined actions. No Basic Output groups are configured.
16-Way Evacuation Control Panel (Mx-4015)	16 inputs are configured to the Alarm 1 action. 6 function inputs are configured to defined actions. 16 Basic Output groups are configured.

Table 4 - I/O Interface Options

The selection will be confirmed – for example:

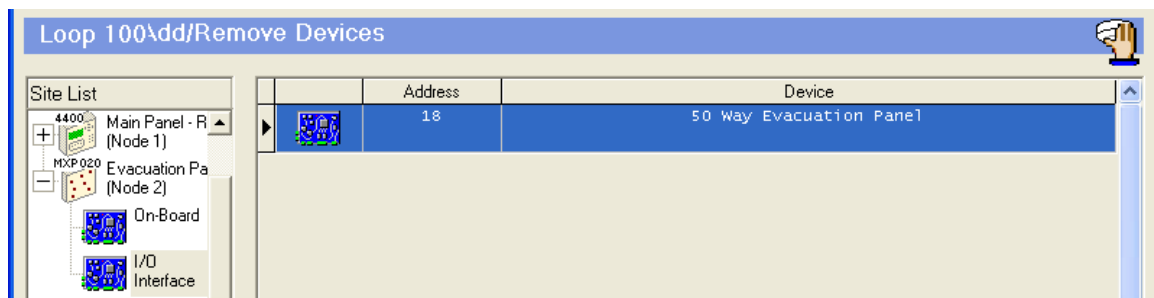

5.2 Output Group Configuration

The 50 Programmable Outputs of the I/O Interface follow the Output Group Programming. For example, Output Number 1 will activate when Output Group 1 becomes active, Output Number 2 will activate when Output Group 2 becomes active, etc.

For each output to be utilised on the interface, an Output Group Rule must be created and defined.

5.2.1 Evacuation Panel

For the Evacuation Panels, Output Group Rules are pre-defined so that operation of the input will activate the associated output. For example, Input 1 will activate Output 1. The LED output should also illuminate when a zone based (or other) cause and effect that directly results in the bells ringing in the evacuation area is also active. This additional cause and effect must be defined.

For example,

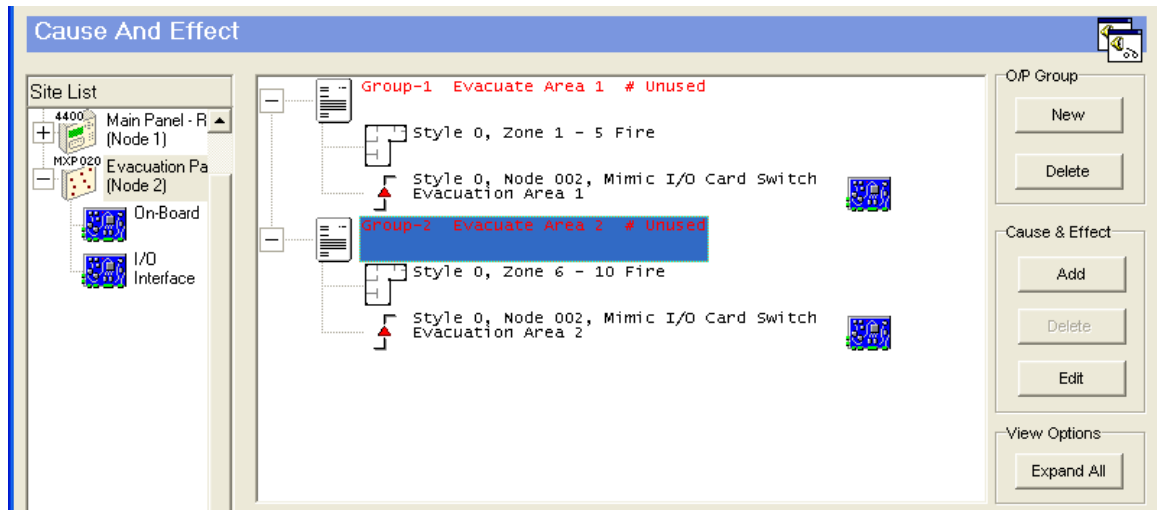

In the above example:

Output 1 LED (Output Group 1) will turn on if there is a fire alarm from any of the zones 1-5 or if Input 1 has been pressed.

Output 2 LED (Output Group 2) will turn on if there is a fire alarm from any of the zones 6-10 or if Input 2 has been pressed.

Repeat the process for each Output LED and Output Group.

These Output Groups must then be copied to, or replicated in, the cause and effects rules of the other panels on the network, as required. The bells in the Evacuation Area will then turn on when there is a fire in the relevant zone or if the associated evacuation input is pressed.



NOTE: The Mimic Interface does not itself activate or control any bells. The panel to which the bells are connected must activate the bells and it can only do this if it is programmed with the same cause and effect.

5.2.2 General I/O Panel

For the General I/O Panel, the Output Groups are not pre-defined.

The LED Outputs on the card can be programmed to respond to any of the available cause and effects in the network. This will normally be associated with cause and effects programmed elsewhere in the network to indicate fires, faults, disablements, alarms or control signals, etc.

For example:

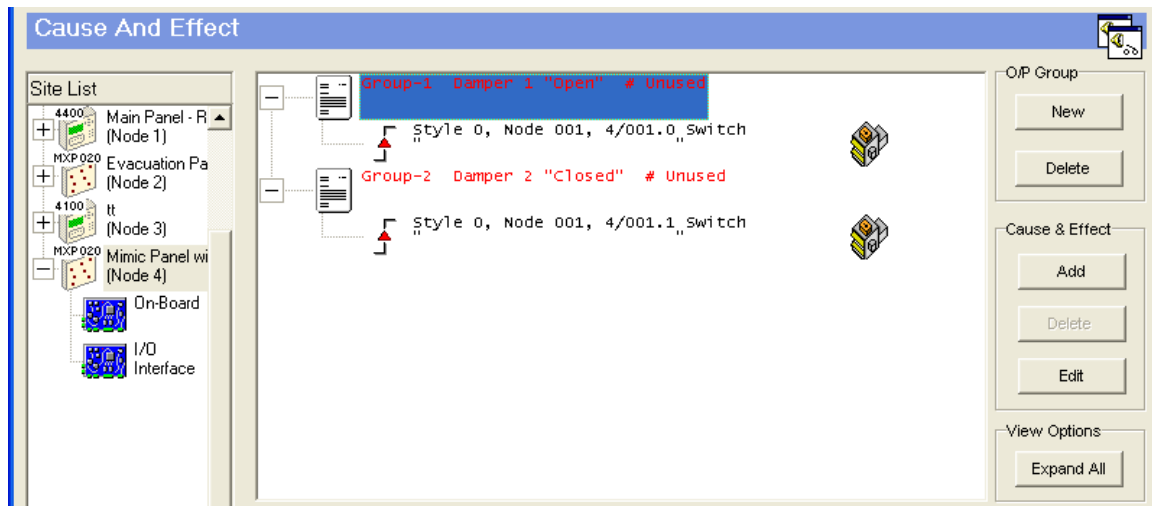

The above view shows output group rules programmed to monitor the status of a damper unit on Loop 4, Address 001 of Node 1.

Output Group 1 monitors the status of the Damper Open Switch. The LED will illuminate when the damper is in the fully open position.

Output Group 2 monitors the status of the Damper Close Switch. The LED will illuminate when the damper is in the fully closed position.

5.3 Switch Input Configuration

When the I/O interface is added, either 56 (50+6) or 22 (16+6) input points are created.

Note: Each input is a sub-address of the base address (18). The sub-addresses are numbered 18.0 – 18.55 or 18.0 – 18.21 respectively.

The 50/16 programmable inputs are located at sub-addresses 0-49 and 0-15 respectively. The Function Inputs are located at sub-addresses 50-55 and 16-21 respectively.

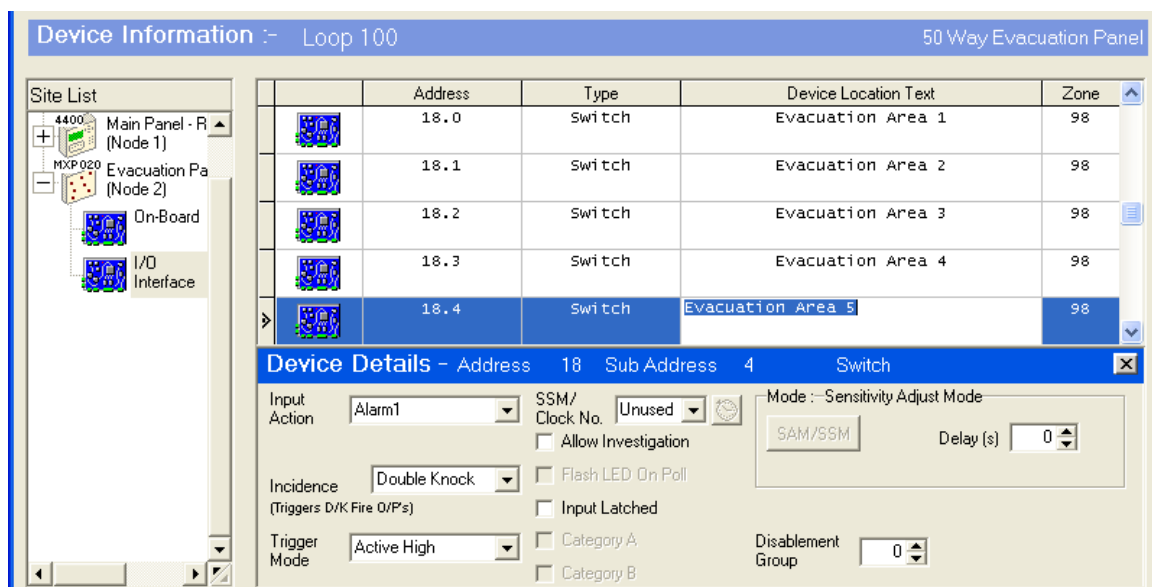

For each input point, it is possible to define the Zone number, Device Text, Input Action, etc. The zone number for all points defaults to the zone number assigned to the interface.

The input actions can be assigned to any of the available Mx-4000 input actions such as Alarm, Control Input, Pre-Alarm, Fire, Fault, etc.

All other input options can be configured as required – refer to the table below and to the Mx-4000 Series Installation and Commissioning Manual (680-014) for further information.

Input Option	Description
Zone	<p>Assign to the zone number required – each input can be assigned to a unique zone if required. It is normally sufficient to leave all inputs assigned to the zone number assigned to the interface.</p> <p>REMEMBER: In combined Evacuation / General panel operation the 8/16 Evacuation Inputs must be assigned to a different zone from the remaining 34/42 General Inputs. For example, assign inputs 01-16 (01-08) to Zone 50 and assign inputs 17-50 (09-50) to Zone 51.</p>
Device Text	<p>Up to 26 characters can be assigned to the device text – use a description to clearly define the input.</p>
Input Action	<p>The available options are; Fire, Pre-Alarm, Fault, Security, Record, Alarm 1/2/3, Key-Lock, No Action, Silence, Re-Sound, Mute, Reset, Disable Group, Control Signal, Fire Evacuate, LED test and Acknowledge.</p> <p>The Function Inputs are pre-assigned to the actions defined in this manual. Only Function Input No. 6 (Spare Input) should be adjusted.</p> <p>The 50-Way Inputs are pre-assigned to Alarm 1 so that an indication is shown on the panel display when active. This is the recommended action for Evacuation Inputs.</p> <p>If the action “Control Signal” is selected for evacuation use, then double pole switches should be used. Connect the first pole of each push button switch to the appropriate individual input. Wire the second pole of all evacuation buttons in parallel and connect to the Function Input No. 4 – The RESOUND Input.</p>
Incidence	<p>Single or Double Knock (default).</p>
Trigger Mode	<p>Active High (default) or Active Low.</p>
Allow Investigation	<p>If this option is selected a fire input can be delayed via the investigation delay function. The default condition is ‘not selected’.</p>
Input Latched	<p>The input signal can be set to latched requiring a reset to be performed to clear the input. The default condition is ‘not latched’.</p>
Disablement Group	<p>The input can be assigned to a disablement group. If the group is disabled then this input will be disabled. If the input action is defined as ‘Group Disable’ then this input will disable the disablement group when active.</p>
SSM / Clock Number	<p>SSM and clock functions are not available.</p>
SAM Delay	<p>The input can be delayed (up to 999 seconds) before it is registered as a valid input. This is useful to filter out transitory / unstable signals. The default delay is zero (0) seconds.</p> <p>SAM – Sensitivity Adjust Mode</p>

Table 5 - Input Configuration Options

6 Example – Evacuation Control and Mimic Panel

The configuration of the evacuation and mimic panel comprises of two basic elements.

- 1) Configuration of the inputs
- 2) Configuration of the output group rules

Consider the following multiple storey building arrangement.

The Numbers alongside the indicators denote the Output Number of the I/O Driver Card used for this LED Indicator. The Numbers alongside the push buttons denote the Input used for this switch.

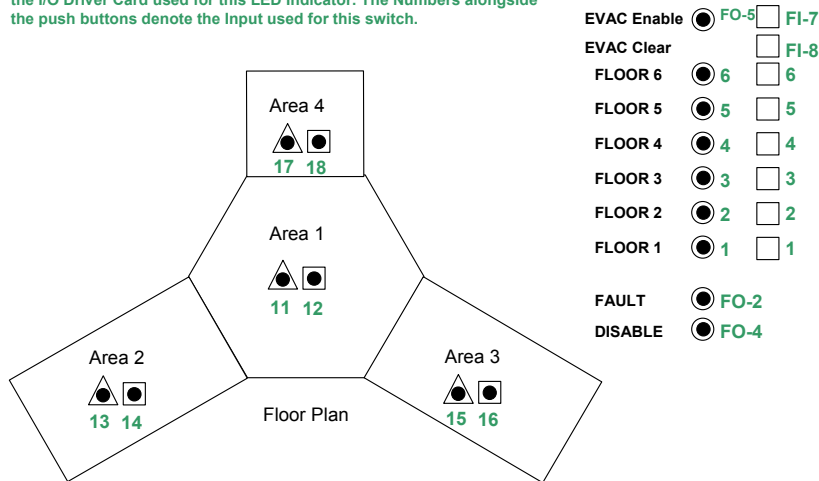

The building is normally divided into an alarm zone (typically each floor) where any fire alarm detected on the floor will ring the bells on that floor. The floor will typically be sub-divided into smaller detection areas (zones) to aid identification of the location. In this example, each floor has four detection zones (Zones 1-4, Zones 5-8, Zones 9-12, etc.).

The graphical arrangement shows a common floor plan for each floor. The indicators will illuminate if there is a fire on any floor for each specific area.

Indicators are placed on the graphical layout to indicate the location of a fire alarm. The key used above is as follows:

- | | |
|---|--|
| <ul style="list-style-type: none"> <input checked="" type="checkbox"/> Indicator for Manual Call Point (MCP) Fire Alarms <input checked="" type="triangle-up"/> Indicator for Automatic Fire Detection (AFD) Fire Alarms <input checked="" type="radio"/> Indicator for Evacuation Zone Alarm Bells Ringing <input type="checkbox"/> Evacuation Push Button | <ul style="list-style-type: none"> Use Output Group Rule Option – CAT A for easy programming Use Output Group Rule Option – CAT B for easy programming |
|---|--|

6.1 Input Configuration

The inputs are pre-configured for 'Alarm-1' input action when the 50-Way Evacuation panel is selected. No further programming is necessary. This example uses the 8/42 combined evacuation function.

The input actions can be changed to a "Control Signal" if no indication is to be shown on any panel display.

6.2 Output Configuration

Create the Output Group Programming Rules in accordance with the details in Table 6 below.

Output Groups 1-6 require two lines of programming each, one for the switch input and one for the zone rule.

The outputs for EVAC Enable, General Fault and General Disablement LED indicators do not require Output Group Programming Rules. These can be driven directly by the Function Outputs.

Indicator	Output Group Programming
1	Input Event – Input 1
	Zone Range – Zone Fire Alarm (Zones 1-4)
2	Input Event – Input 2
	Zone Range – Zone Fire Alarm (Zones 5-8)
3	Input Event – Input 3
	Zone Range – Zone Fire Alarm (Zones 9-12)
4	Input Event – Input 4
	Zone Range – Zone Fire Alarm (Zones 13-16)
5	Input Event – Input 5
	Zone Range – Zone Fire Alarm (Zones 17-20)
6	Input Event – Input 6
	Zone Range – Zone Fire Alarm (Zones 21-24)
11	Zone Ranges – Zone CAT A Fire Alarm (Zones, 1, 5, 9, 13, 17, 21)
12	Zone Ranges – Zone CAT B Fire Alarm (Zones, 1, 5, 9, 13, 17, 21)
13	Zone Ranges – Zone CAT A Fire Alarm (Zones, 2, 6, 10, 14, 18, 22)
14	Zone Ranges – Zone CAT B Fire Alarm (Zones, 2, 6, 10, 14, 18, 22)
15	Zone Ranges – Zone CAT A Fire Alarm (Zones, 3, 7, 11, 15, 19, 23)
16	Zone Ranges – Zone CAT B Fire Alarm (Zones, 3, 7, 11, 15, 19, 23)
17	Zone Ranges – Zone CAT A Fire Alarm (Zones, 4, 8, 12, 16, 20, 24)
18	Zone Ranges – Zone CAT B Fire Alarm (Zones, 4, 8, 12, 16, 20, 24)

Table 6 - Evacuation / Mimic Panel Output Rules

Example: - Output 1

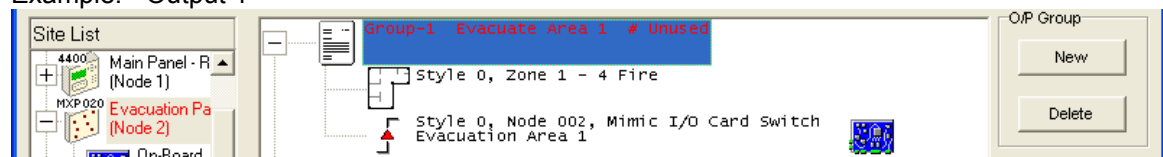

Example: Output 11

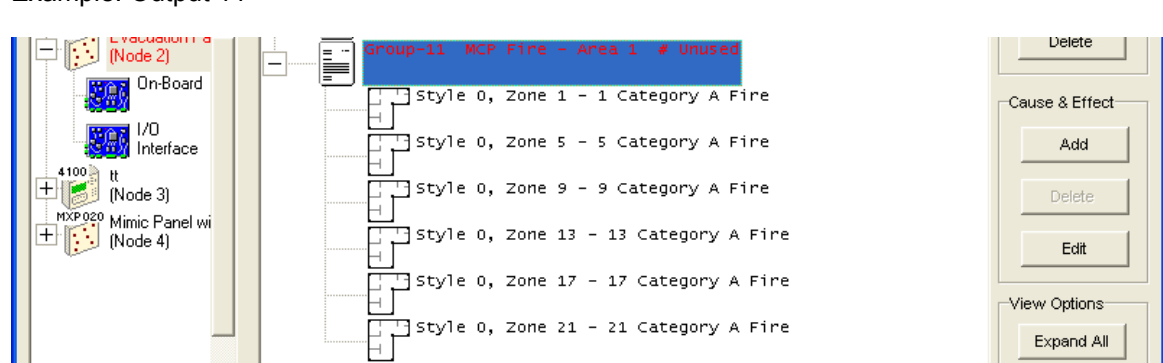

Indicators 1-6 have been defined for the Evacuation function indications (i.e. bells / sounders ringing in the specific area).

Indicators 11-18 have been defined for the Mimic indications.

Copy the Output Group Rules created to the cause and effects of the other panels.

The procedure for an Evacuation Only Panel is identical to the above example except for the programming of the mimic indications.

7 Maintenance

7.1 Lithium Battery



WARNING – A lithium battery is used for data retention / operation of the real time clock. Replace only with the same type or authorised equivalent. This battery is not rechargeable.

Expected Shelf Life	- > 10 years
Replacement Schedule	- 10 years for panels in continuous service 10 years for spares (i.e. when the panel / board is not powered) Replace if the battery voltage falls below 2.6 volts.
Manufacturer / Part Number	- CR2032